

Varenummer: 203160M1675B4U

Beskrivelse: E+G Justerfod

GN 31-60-M16-75-B4-U

Note: U Uden møtrik, sekskant i toppen, spændeflade i bunden

Mål

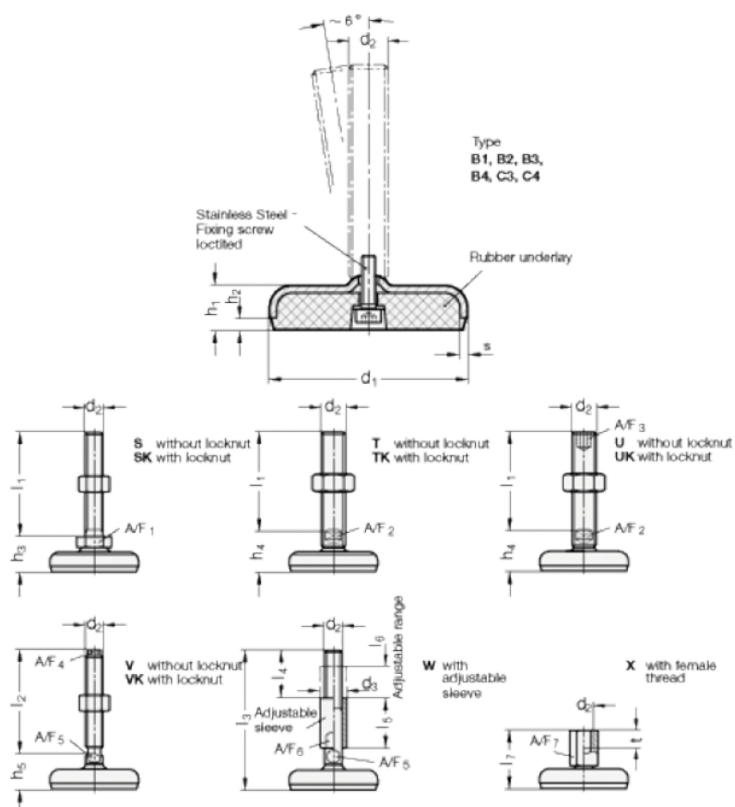

A/F2	= 12	s = 3
A/F3	= 8	
d1	= 60	
d2	= 16	
h1	= 16	
h2	= 4	
h4 +4.0/0	= 30	
l1	= 75	